

Installation Guidelines

RPS20

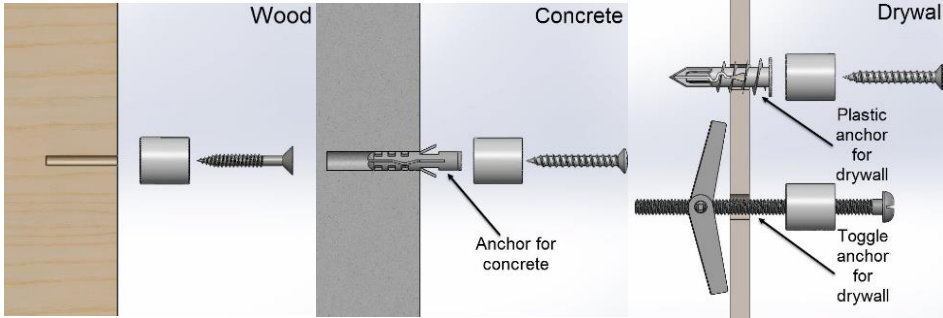

Installation Tips



To ensure a secure installation it is important to verify that the mounting area is strong enough to support the weight of the items being mounted, while also supporting the weight of the rod and supports. All installation must be done with proper hardware and correct measures to ensure safety. Make sure to check that the parts are properly installed and secured at the end of each installation. Please follow the below step by step guide for MBS's recommended installation.

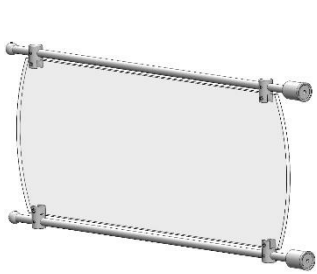

1 Mark the locations where the mounts will be installed. Depending on mounting surface and mounting method pre-drill 1 hole for the anchoring system. Example: Concrete would need 1 pre-drilled 1/4" hole to accept the concrete anchors.

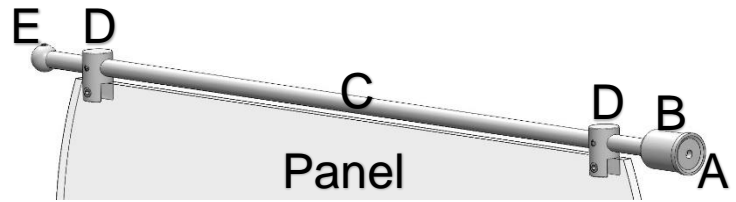

2 Unscrew the rod mount Part (B) from the wall support (Part A). Drop screw through (Part A) and drill to the wall. Once the wall support is firmly placed thread rod mount (Part B) tight onto the wall support (Part A).

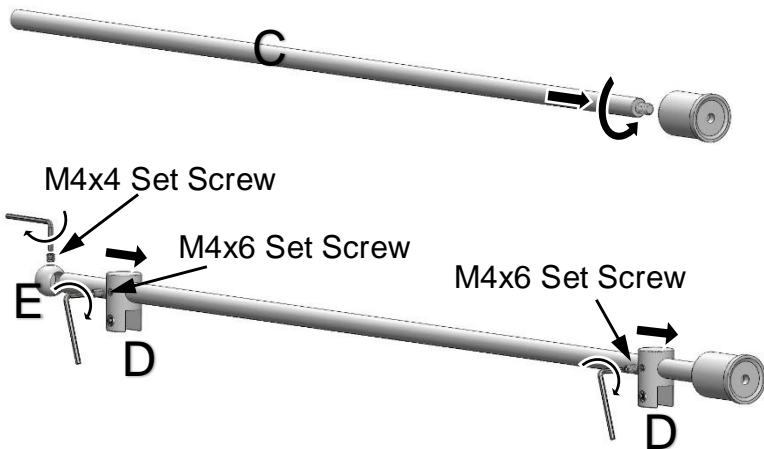
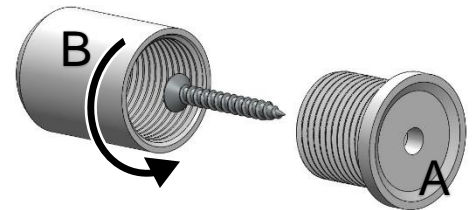

3 Thread Rod Part (C) into Rod support Part (B). Check Stability of the mounted rods. Remove the M4 set screw with a M4 allen key from the panel grips (Part D) and slide them into place on the rod and tighten set screws to keep in place.

4 If the Ball end Accessory (Part E) was purchased set in place at end of rod and tighten down the M4 set screw.

5 To apply your sign remove the M6 set screws from the panel grips (Part D). Slide the Sign in pace and tighten down the M6 set screws firmly.

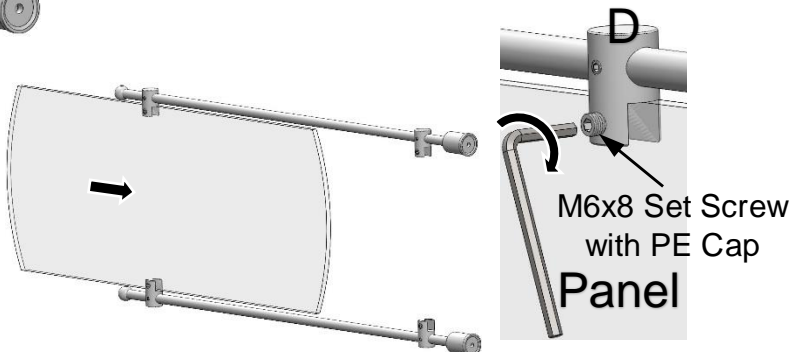

NOTE: It is very important to double check and ensure that the mounted hardware is installed properly. MBS takes no responsibility for incorrect installation that responsibility rests with the installer.

Address: Htm-Mbs
6420 Benjamin Rd,
Tampa, FL. 33634



Phone : 1-813-938-6025
Fax : 1-813-425-9007
Mail: sales@mbs-standoffs